 **Bonfiglioli**
Industrial

Solutions for
Crane Applications

Solutions for **Crane Applications**

With more than 60 years of experience in integrated power transmission solutions, Bonfiglioli offers a complete range of gearboxes and gearmotors for cranes and lifting equipment.

High productivity, reliable power transmission under all conditions are a prerequisite for crane applications. The undisputed reliability and durability of Bonfiglioli's "Heavy Duty" series permit continuous duty over an extended lifetime.

The availability of high protection ratings for gearboxes and motors make Bonfiglioli solutions ideal for indoor and outdoor installations, even in marine environments.

Modular gearbox design and special solutions for fast, easy maintenance of the entire power train help end users minimizing scheduled maintenance downtime.

Bonfiglioli's wide range of inverters allows special "complete drive solutions" for hoist, trolley and travel drives. Our closed loop inverters feature special functions like "brake release control" and "field weakening motor speed control" improve safety and increase productivity in hoisting operations. Our open loop inverters feature an innovative "stand-by" function to maximise the efficiency of trolley and travel drives under no-load conditions.

Bonfiglioli's vast expertise, acquired through long term partnerships with some of the world's leading manufacturers of lifting equipment, is at disposal of crane and hoist constructors around the world. Our widespread sales and service network ensures the availability of spare parts and technical support, anytime and anywhere.



Solutions for terminal and harbour outdoor applications
Gantry Crane

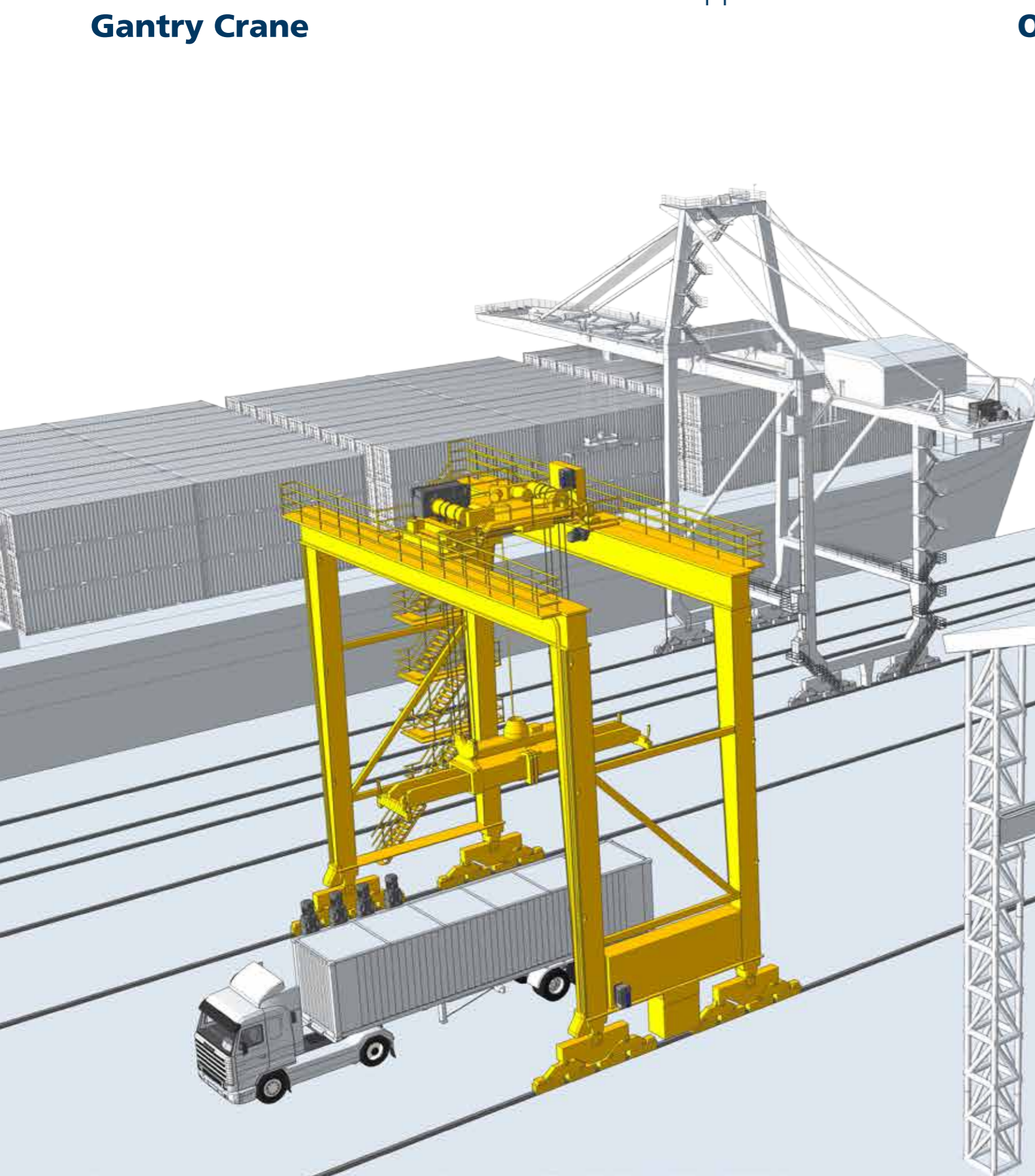

Solutions for industrial indoor applications
Overhead Crane

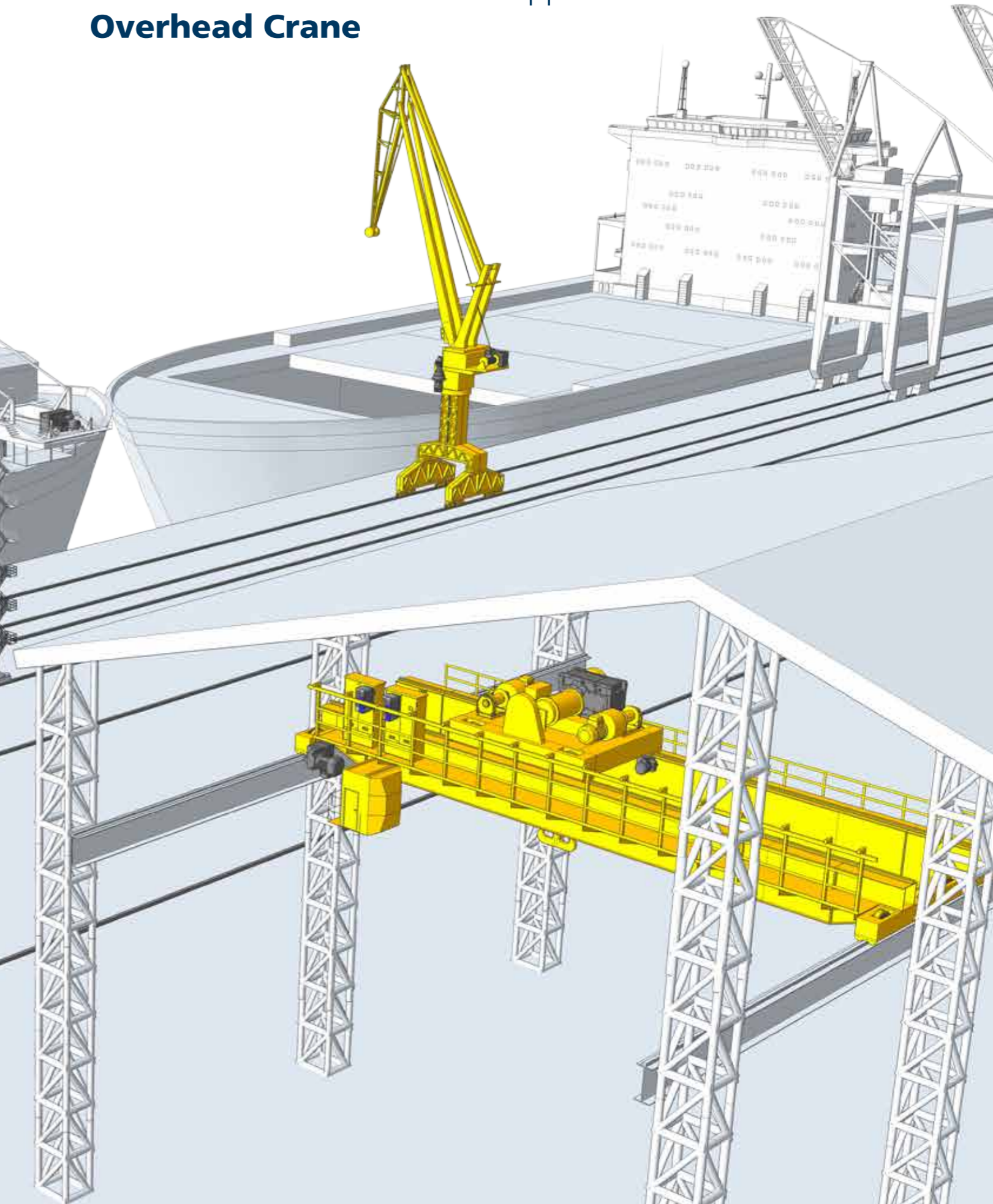

Solutions for terminal and harbour outdoor applications Gantry Crane

Customized solutions, service and support

- Pre-Sales support and co-engineering (FEM standard analysis, gears and bearings lifetime calculation according to required standards, load verifications etc.)
- Technical features as per Customer needs (special output shaft design and auxiliar devices like brakes, couplings etc.)
- Severe environment condition solutions (painting, seals etc.)
- Accessories for motion control and safety (inverters, motors, encoders, brakes etc.)
- Shaft mounted solutions with torque arm or solutions with baseplate



Solutions for Hoist of Gantry Crane



HDP series

Torque range
5000 ... 210000 Nm

Gear ratios
7.1 ... 500

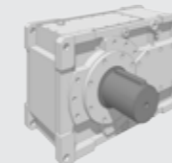

300 series

Torque range
1250 ... 1286000 Nm

Gear ratios
3.4 ... 5234



3/H series

Torque range
98000 ... 1200000 Nm

Gear ratios
100 ... 1000

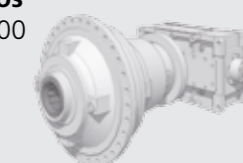

Solutions for Trolley of Gantry Crane



F series / HDP series

Torque range
140 ... 210000 Nm

Gear ratios
6.4 ... 2099

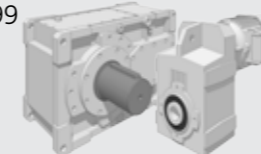

300 series / C series

Torque range
45 ... 1286000 Nm

Gear ratios
2.6 ... 5234

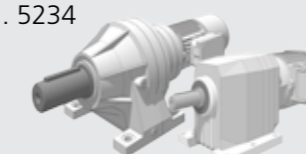

A series

Torque range
100 ... 14000 Nm

Gear ratios
5.4 ... 1715

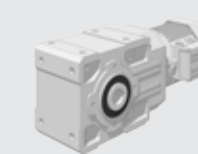

Solutions for Travel of Gantry Crane



A series

Torque range
100 ... 14000 Nm

Gear ratios
5.4 ... 1715



300R series

Torque range
1000 ... 500000 Nm

Gear ratios
7.13 ... 953



HDO series

Torque range
28200 ... 210000 Nm

Gear ratios
5.6 ... 400

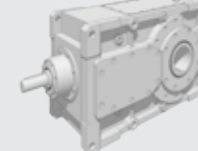

Solutions for industrial indoor applications Overhead Crane

Benefits for the customer

- Productivity, reliability and robustness
- Extensive, modular product range
- Tailored service and warranty plans
- Long term experience in crane drive control
- Lower thermal losses
- Selectable sine or square wave feedback current
- Load-dependent hoisting speed
- Extended brake control
- Built-in "Safe torque off" function

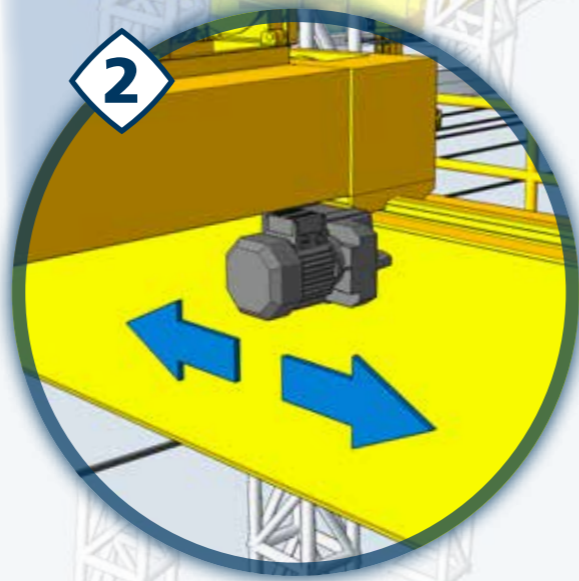
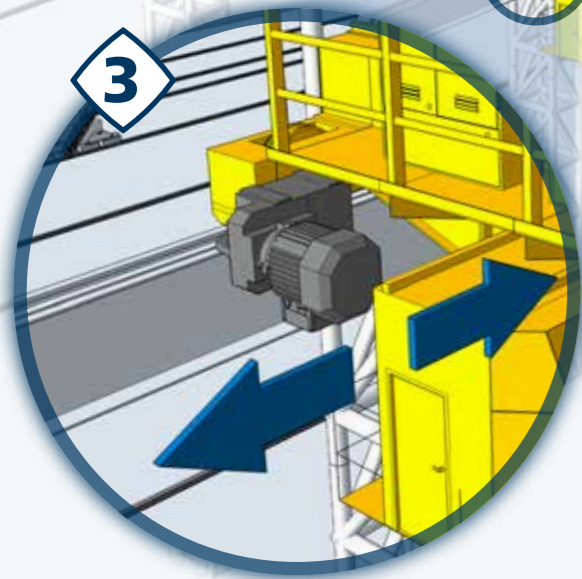
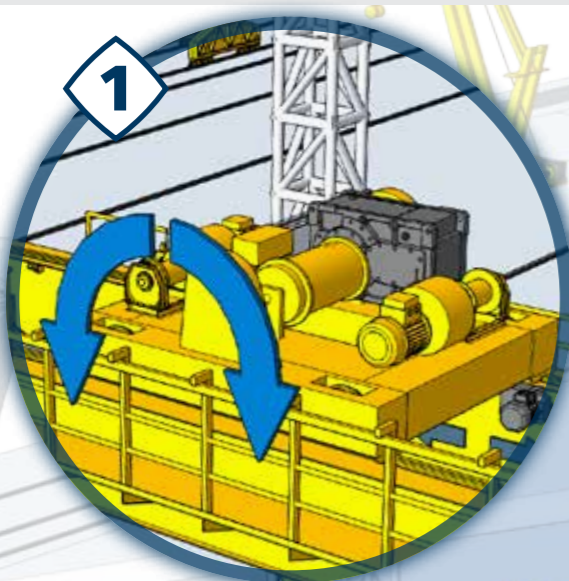

Solutions for Hoist of Overhead Crane

1

HDP series

Torque range
5000 ... 210000 Nm

Gear ratios
7.1 ... 500

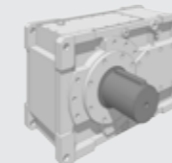

300 series

Torque range
1250 ... 1286000 Nm

Gear ratios
3.4 ... 5234

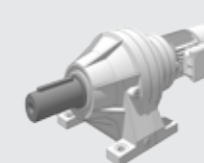

F series

Torque range
140 ... 14000 Nm

Gear ratios
6.4 ... 2099

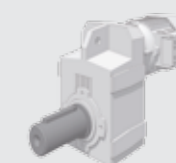

Solutions for Trolley of Overhead Crane

2

F series / HDP series

Torque range
140 ... 210000 Nm

Gear ratios
6.4 ... 2099

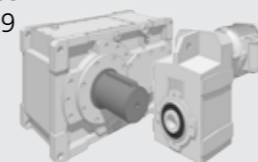

300 series / C series

Torque range
45 ... 1286000 Nm

Gear ratios
2.6 ... 5234

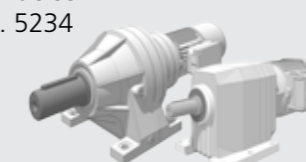

A series

Torque range
100 ... 14000 Nm

Gear ratios
5.4 ... 1715



Solutions for Travel of Overhead Crane

3

F series / HDP series

Torque range
140 ... 210000 Nm

Gear ratios
6.4 ... 2099

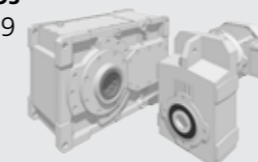

300 series / A series

Torque range
100 ... 1286000 Nm

Gear ratios
3.4 ... 5234

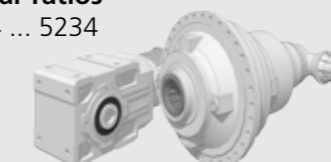

C series

Torque range
45 ... 12000 Nm

Gear ratios
2.6 ... 1481

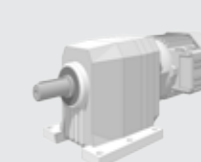

Solutions for terminal and harbour outdoor applications Boom Shipyard single and double

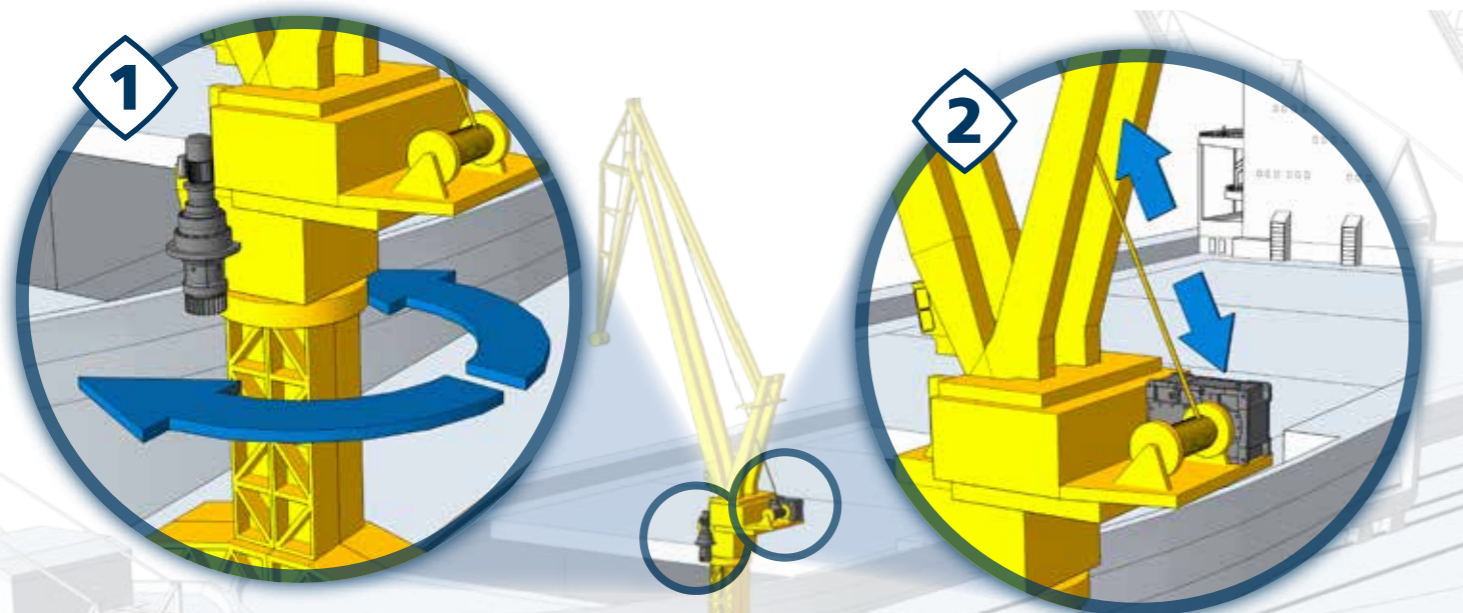

1 Solutions for **Slewing Drive of S/D Boom Shipyard**

300 series SCN/SCF-SEN/SEF

Torque range
2000 ... 65000 Nm



Note
Calculation Ref. FEM T5 L2 M5
Output speed $n_2 = 15$ rpm

2 Solutions for **Hoist of S/D Boom Shipyard**

HDO series / HDP series

Torque range
5000 ... 210000 Nm

Gear ratios
7.1 ... 500

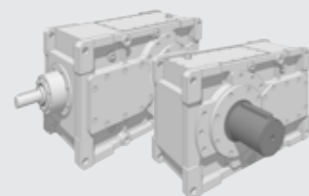

Motion and Control Solutions

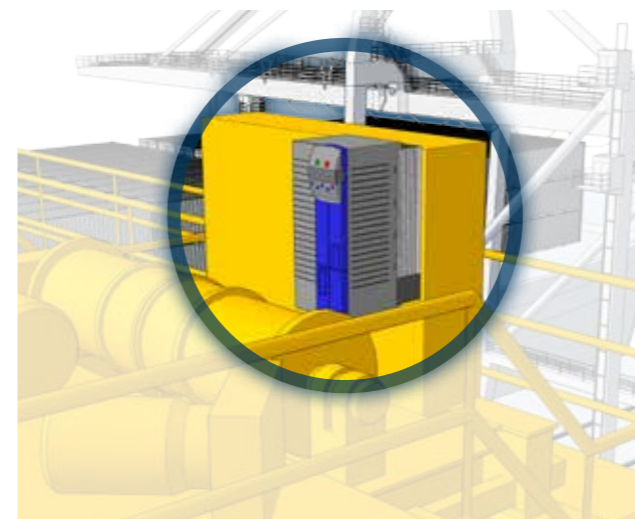

Regenerative & Servo Drive

Active Cube series

Power range
ACU401: 0.25 ... 400 kW*
ACU201: 0.25 ... 9.2 kW
(*1200 kW in parallel connection)



Additional benefits

- Highest power density in the market
- "Safe Torque Off" function
- PLC as integrated functionality
- Open/Closed speed loop control
- Integrated positioning control
- Advanced motor brake control
- Availability of the most used fields bus
- Availability of additional I/O

Agile series

Power range
AGL402: 0.25 ... 11 kW
AGL202: 0.12 ... 7.5 kW



Additional benefits

- Highest power density in the market
- "Safe Torque Off" function
- PLC as integrated functionality
- Advanced motor brake control
- Availability of the most used fields bus

AEC series (Regenerative unit)

Power range
9.7 ... 173.2 kVA



Additional benefits

- Highest power density in the market
- Active brake unit to recover the braking energy
- Availability of the most used fields bus
- Availability of additional I/O

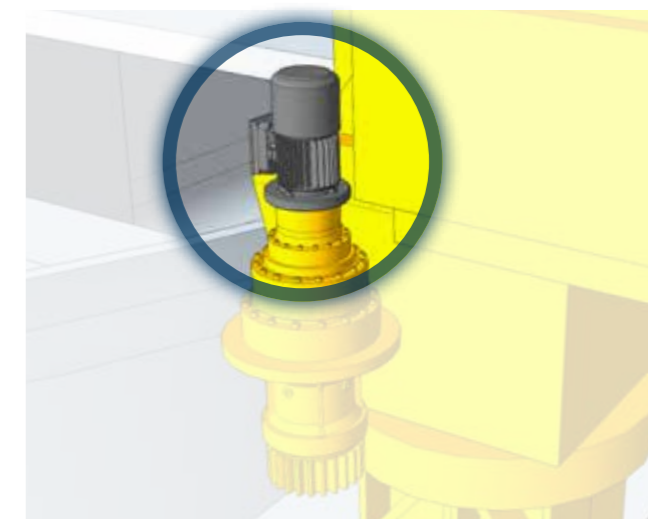

AC Motors

M/BN series (Brake motor)

kW rating (4 pole)
0.06 ... 30 kW

Pole numbers

2, 4, 6, 8, 2/4, 2/6, 2/8, 2/12, 4/6, 4/8

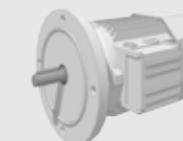

Main Options

- DC brake [FD]
- Separate brake supply
- Microswitch
- Protection degree up to IP55
- Incremental and absolute Encoder availability
- Thermal protection (Bi-metallic or Ptc)
- Heater and tropicalization
- Anti-condensate drain

ME/BE - MX/BX series

kW rating (4 pole)
0.75 ... 22 kW

Pole numbers

2, 4, 6 (MX/BX 4 poles only)



IE2

IE3

Main Options

- High efficiency motors
- Protection degree up to IP65
- Incremental and absolute Encoder availability
- Thermal protection (Bi-metallic or Ptc)
- Heater and tropicalization
- Anti-condensate drain

Accessories

Torque Arm

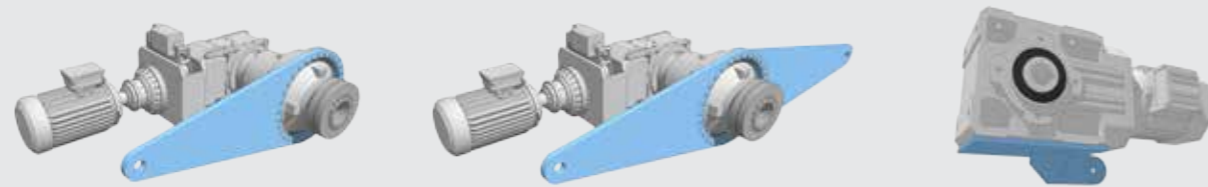

Baseplate



Splined shaft

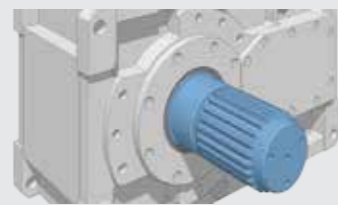

Splined shaft + Flange coupling



Splined Coupling

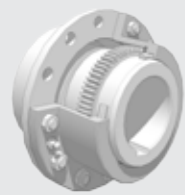

Flange Coupling

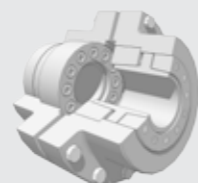

Self Aligning Coupling



Shoe Brake

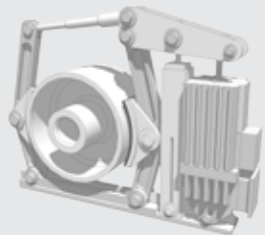

Disk Brake



Double Key way (120°)

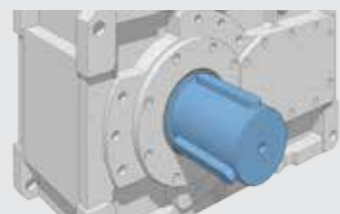

Special Elastic Coupling

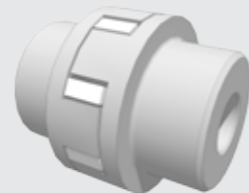

Heavy Environment Solutions

- Double seals
- Viton seals
- Taconite seals
- Heaters, Greaser, Sensors (Low temperature, dust environment)
- Special painting (Marine, dust environment)



Taconite seals

Heater wire

Customer Support & Certifications

- Application support and product selection
- Gearboxes calculations (FEM analysis, Life time ISO 281, ISO 6336, AGMA)
- Gearboxes test certificates



On request:

- Quality documentations and certifications
- Certifications (DNV, LLOYD, ABS..)

Bonfiglioli Worldwide

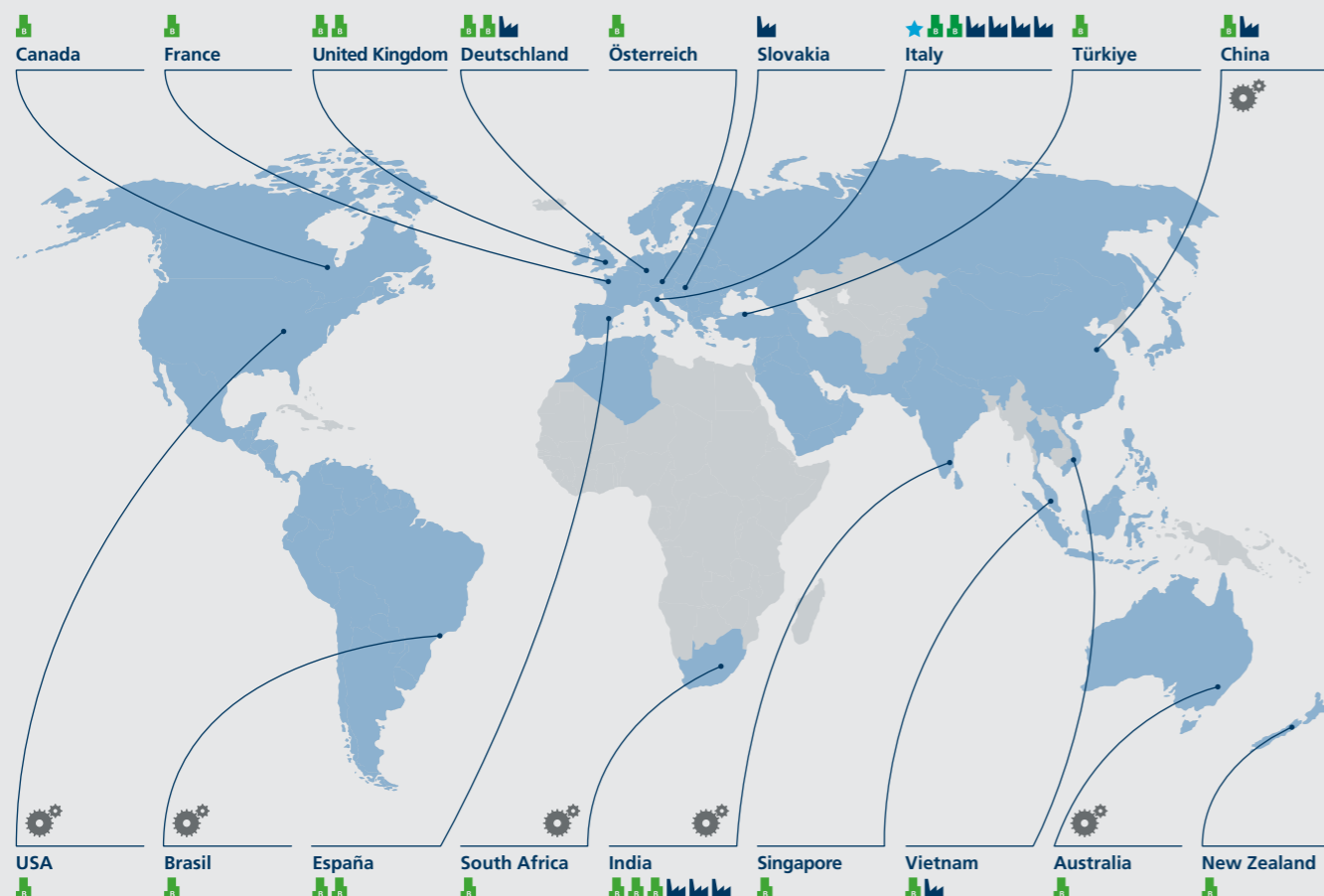

Headquarters

ITALY • Lippo di Calderara, Bologna



Branches

AUSTRALIA • Sydney
AUSTRIA • Wiener Neustadt
BRAZIL • São Paulo
CANADA • Toronto
CHINA • Shanghai
FRANCE • Paris
GERMANY • Neuss
GERMANY • Krefeld
INDIA • Chennai
INDIA • Mannur
INDIA • Bangalore
ITALY • Milano
ITALY • Rovereto
NEW ZEALAND • Auckland
SOUTH AFRICA • Johannesburg
SINGAPORE • Singapore
SPAIN • Barcelona
SPAIN • Madrid
TURKEY • Izmir
UNITED KINGDOM • Redditch
UNITED KINGDOM • Warrington
USA • Cincinnati
VIETNAM • Ho Chi Minh



Production facilities

ITALY • Calderara di Reno, Bologna
 Casting and gearcutting plant
 Assembly HDP, HDO, 300 series
ITALY • Vignola, Modena
 Gearmotor assembly plant
 Precision gearbox manufacturing and assembly plant
ITALY • Forlì
 Planetary gearboxes manufacturing and assembly plant
ITALY • Rovereto, Trento
 Brushless motor production
GERMANY • Krefeld
 Inverter plant
SLOVAKIA • Považská Bystrica
 Large gearboxes manufacturing plant
INDIA • Chennai
 Planetary gearbox manufacturing and assembly plant
INDIA • Mannur
 Gearmotors manufacturing and assembly plant
INDIA • Bangalore
 Photovoltaic Inverter assembly
VIETNAM • Ho Chi Minh
 Electric motor plant
CHINA • Shanghai
 Photovoltaic Inverter assembly



Heavy duty assembly dept.

AUSTRALIA • Sydney
BRAZIL • São Paulo
CHINA • Shanghai
INDIA • Chennai
SOUTH AFRICA • Johannesburg
USA • Cincinnati



Resellers

AFRICA • Algeria, Egypt, Kenya, Morocco, South Africa, Tunisia
ASIA • Bahrain, China, Emirates, Japan, Jordan, Hong Kong, India, Indonesia, Iran, Israel, Kuwait, Malaysia, Oman, Pakistan, Philippine, Qatar, Saudi Arabia, Singapore, South Korea, Syria, Thailand, Taiwan, Vietnam
EUROPE • Albania, Austria, Belgium, Bielorusia, Bulgaria, Cyprus, Croatia, Czech Republic, Denmark, Estonia, Finland, France, Holland, Hungary, Germany, Great Britain, Greece, Ireland, Italy, Lettonia, Lituania, Luxemburg, Malta, Montenegro, Norway, Poland, Portugal, Romania, Russia, Slovakian Republic, Serbia, Slovenia, Spain, Sweden, Switzerland, Turkey, Ucraina
LATIN AMERICA • Argentine, Bolivia, Brasil, Chile, Colombia, Costa Rica, Ecuador, Guatemala, Honduras, Mexico, Peru, Uruguay, Venezuela
NORTH AMERICA • Canada, United States
OCEANIA • Australia, New Zealand

Bonfiglioli Worldwide Network

Bonfiglioli Australia

2, Cox Place Glendenning NSW 2761
 Locked Bag 1000 Plumpton NSW 2761
 Tel. (+ 61) 2 8811 8000 - Fax (+ 61) 2 9675 6605
www.bonfiglioli.com.au

Bonfiglioli Brasil

Travessa Cláudio Armando 171
 Bloco 3 - CEP 09861-730 - Bairro Assunção
 São Bernardo do Campo - São Paulo
 Tel. (+55) 11 4344 2323 - Fax (+55) 11 4344 2322
www.bonfigliolidobrasil.com.br

Bonfiglioli Canada

2-7941 Jane Street - Concord, Ontario L4K 4L6
 Tel. (+1) 905 7384466 - Fax (+1) 905 7389833
www.bonfigliolicanada.com

Bonfiglioli China

Unit D, 8th Floor, Building D, BenQ Plaza, No.207
 Songhong Road, Shanghai 200335
 Tel. (+86) 21 60391118 - Fax (+86) 59702957
www.bonfiglioli.cn

Bonfiglioli Deutschland

Industrial, Mobile, Wind
 Sperberweg 12 - 41468 Neuss
 Tel. +49 (0) 2131 2988 0 - Fax +49 (0) 2131 2988 100
www.bonfiglioli.de
Industrial, Photovoltaic
 Europark Fichtenhain B6 - 47807 Krefeld
 Tel. +49 (0) 2151 8396 0 - Fax +49 (0) 2151 8396 999
www.vectron.net

Bonfiglioli España

Industrial, Mobile, Wind
 Tecnotrans Bonfiglioli S.A.
 Pol. Ind. Zona Franca sector C, calle F, n°6
 08040 Barcelona
 Tel. (+34) 93 4478400 - Fax (+34) 93 3360402
www.tecnotrans.com
Photovoltaic
 Bonfiglioli Renewable Power Conversion Spain, SL
 Ribera del Loira, 46 - Edificio 2 - 28042 Madrid
 Tel. (+34) 91 5030125 - Fax (+34) 91 5030099
www.tecnotrans.com

Bonfiglioli France

14 Rue Eugène Pottier
 Zone Industrielle de Moimont II - 95670 Marly la Ville
 Tel. (+33) 1 34474510 - Fax (+33) 1 34688800
www.bonfiglioli.fr

Bonfiglioli India

Industrial
 Bonfiglioli Transmission PVT Ltd.
 Survey No. 528, Perambakkam High Road
 Mannur Village - Sriperumbudur Taluk 602105
www.bonfiglioli.in
Mobile, Wind
 Bonfiglioli Transmission PVT Ltd.
 PLOT AC7-AC11 Sidco Industrial Estate
 Thirumudivakkam - Chennai 600 044
 Tel. +91(0) 44 24781035 - 24781036 - 24781037
 Fax +91(0) 44 24780091 - 24781904
www.bonfiglioli.in
Photovoltaic
 Bonfiglioli Renewable Power Conversion India (P) Ltd
 No. 543, 14th Cross, 4th Phase,
 Peenya Industrial Area, Bangalore - 560 058
 Tel. +91 80 2836 1014/15 - Fax +91 80 2836 1016
www.bonfiglioli.in

Bonfiglioli Italia

Industrial, Photovoltaic
 Via Sandro Pertini lotto 7b - 20080 Carpiano (Milano)
 Tel. (+39) 02 985081 - Fax (+39) 02 985085817
www.bonfiglioli.it
Bonfiglioli Mechatronic Research
 Via F. Zeni 8 - 38068 Rovereto (Trento)
 Tel. (+39) 0464 443435/36 - Fax (+39) 0464 443439
www.bonfiglioli.it

Bonfiglioli New Zealand

88 Hastie Avenue, Mangere Bridge, Auckland
 2022, New Zealand - PO Box 11795, Ellerslie
 Tel. (+64) 09 634 6441 - Fax (+64) 09 634 6445
www.bonfiglioli.co.nz

Bonfiglioli Österreich

Molkereistr 4 - A-2700 Wiener Neustadt
 Tel. (+43) 02622 22400 - Fax (+43) 02622 22386
www.bonfiglioli.at

Bonfiglioli South East Asia

24 Pioneer Crescent #02-08
 West Park Bizcentral - Singapore, 628557
 Tel. (+65) 6268 9869 - Fax. (+65) 6268 9179
www.bonfiglioli.com

Bonfiglioli South Africa

55 Galaxy Avenue,
 Linbro Business Park - Sandton
 Tel. (+27) 11 608 2030 OR - Fax (+27) 11 608 2631
www.bonfiglioli.co.za

Bonfiglioli Türkiye

Atatürk Organize Sanayi Bölgesi,
 10044 Sk. No. 9, 35620 Çiğli - Izmir
 Tel. +90 (0) 232 328 22 77 (pbx)
 Fax +90 (0) 232 328 04 14
www.bonfiglioli.com.tr

Bonfiglioli United Kingdom

Industrial, Photovoltaic
 Unit 7, Colemeadow Road
 North Moons Moat - Redditch,
 Worcestershire B98 9PB
 Tel. (+44) 1527 65022 - Fax (+44) 1527 61995
www.bonfiglioli.co.uk
Mobile, Wind
 3 - 7 Grosvenor Grange, Woolston
 Warrington - Cheshire WA1 4SF
 Tel. (+44) 1925 852667 - Fax (+44) 1925 852668
www.bonfiglioli.co.uk

Bonfiglioli USA

3541 Hargrave Drive Hebron, Kentucky 41048
 Tel. (+1) 859 334 3333 - Fax (+1) 859 334 8888
www.bonfiglioliusa.com

Bonfiglioli Vietnam

Lot C-9D-CN My Phuoc Industrial Park 3
 Ben Cat - Binh Duong Province
 Tel. (+84) 650 3577411 - Fax (+84) 650 3577422
www.bonfiglioli.vn



Bonfiglioli has been designing and developing innovative and reliable power transmission and control solutions for industry, mobile machinery and renewable energy applications since 1956.

HEADQUARTERS

Bonfiglioli Riduttori S.p.A.
Via Giovanni XXIII, 7/A
40012 Lippo di Calderara di Reno
Bologna (Italy)

tel: +39 051 647 3111
fax: +39 051 647 3126
bonfiglioli@bonfiglioli.com
www.bonfiglioli.com

BR_CAT_CRANE_STD_ENG_R01_0

